



CHOSEN FOR CHARACTER

ESTABLISHED 1925



SPECIAL SHAPED BRICKS GUIDE

Foreword

This edition of the booklet has been prepared in accordance with the proposed BS 4729:2005. This is the supporting Standard for the new European Standard EN771-1. The specification of bricks in this booklet will follow the procedure detailed in EN771-1. The alpha-numeric coding system is now established and used in both the Standard and this brochure.

This British Standard has been prepared under the direction of the Clay and Calcium Silicate Products Standards Policy Committee. It is a revision of BS 4729:1990, which is withdrawn.

Extracts from British Standards are reproduced with the permission of BSI. Complete copies can be obtained by post from BSI Sales, Linford Wood, Milton Keynes MK14 6LE. Fax: 01908 320856

The Guide

Northcot Brick has produced this guide to special shaped bricks.

We hope that it will provide a useful aid to specification and choice and help to keep brick in the forefront of current design and building.

We will be glad to give advice on all our bricks and specials.

Please contact the Sales Office by telephone on 01386 700551 or by email

info@northcotbrick.co.uk

Contents

Bonding Bricks	GROUP BD	5
Copings and Cappings	GROUP CP	7
Bullnose Bricks	GROUP BN	9
Angle and Cant Bricks	GROUP AN	18
Plinth Bricks	GROUP PL	26
Arch Bricks	GROUP AR	30
Radial Bricks	GROUP RD	31
Brick Slips	GROUP SL	32
Soldier Bricks	GROUP SD	33
Victorian Old Type Specials	GROUP VN	34
Appendices		39
Specifications		42

Bonding Bricks

GROUP BD

Typically used where there is a requirement for non full-size pieces of brick.

HALF BAT (snapheader)

BD.1.1

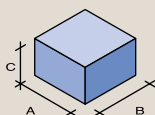
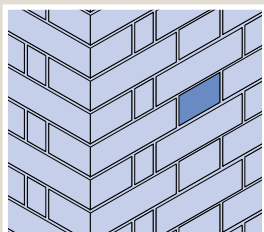

TYPE	A	B	C
BD.1.1	102	102	65

THREE-QUARTER BAT

BD.1.2

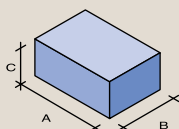
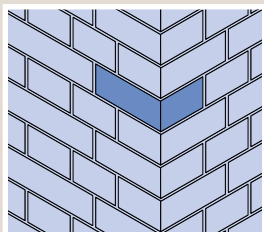

TYPE	A	B	C
BD.1.2	159	102	65

STANDARD BRICK FAIR-FACED ON BED SURFACE

BD.1.3

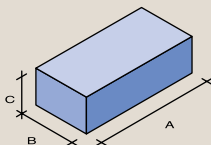
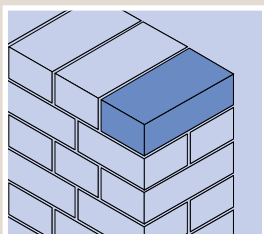

TYPE	A	B	C
BD.1.3	215	102	65

NOTE: Faced on 2 headers
1 stretcher and 1 bed



Bonding Bricks

GROUP BD

KING CLOSER (left and right hand)

BD.2

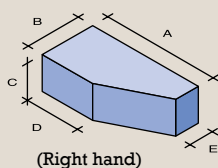
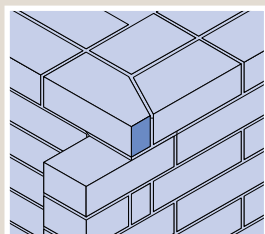

TYPE	A	B	C	D	E
BD.2	215	102	65	102	46

QUEEN CLOSER

BD.3

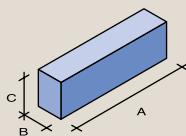
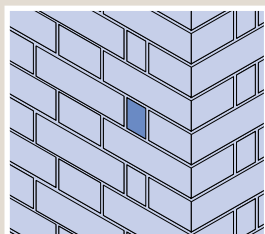

TYPE	A	B	C
BD.3	215	46	65

SQUARE STOP END

BD.4

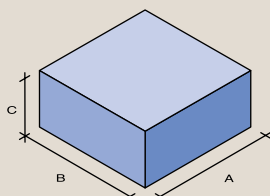
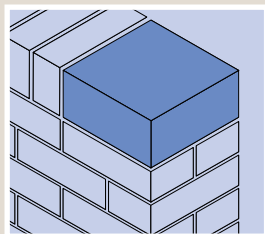

TYPE	A	B	C
BD.4.1	215	159	102
BD.4.2	215	159	65
BD.4.3	215	215	102
BD.4.4	215	215	65

NOTE: Faced on 3 stretchers and 1 bed

Copings and Cappings

GROUP CP

Typical uses are as a decorative finish to parapet walls and free-standing walls and to protect the brickwork beneath.

Note: All copings and cappings must be frost resistant i.e. F2 to BSEN771-1. Copings always overhang the brickwork beneath; cappings are flush with the vertical brickwork. It is also recommended that careful consideration is given to the detailing below both copings and cappings.

HALF ROUND COPING

CP.1.1

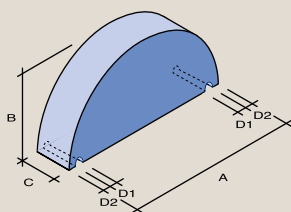
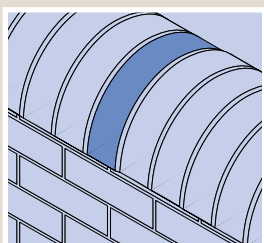

TYPE	A	B	C	D ₁	D ₂
CP.1.1	305	153	65	13	15

HALF ROUND CAPPING

CP.1.2

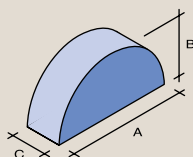
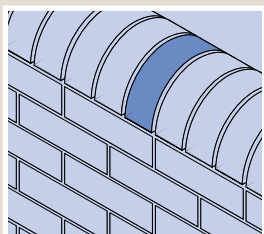

TYPE	A	B	C
CP.1.2	215	108	65

Copings and Cappings

GROUP CP

SADDLEBACK COPING

CP.2.1

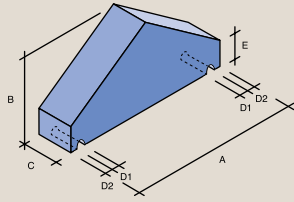
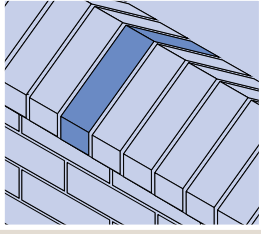

TYPE	A	B	C	D ₁	D ₂	E
CP.2.1	305	153	65	13	15	50

SADDLEBACK CAPPING

CP.2.2

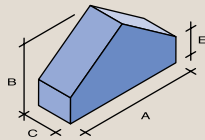
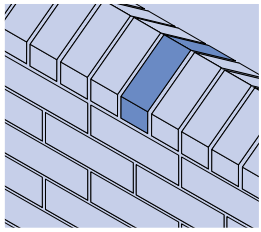

TYPE	A	B	C	E
CP.2.2	215	123	65	50

Bullnose Bricks

GROUP BN

Typically used for feature brickwork where a radius is required, for example, corner details, window/door reveals, pier work. Can also act as capping (see Group CP) or for edging kerbs. This group also includes special bricks to provide an aesthetic visual transition between square and curved elements.

SINGLE BULLNOSE (left and right hand)

BN.1

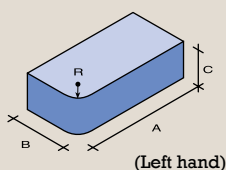
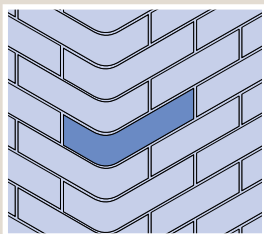

TYPE	A	B	C	R
BN.1.1	215	103	65	25
BN.1.2	215	103	65	51

DOUBLE BULLNOSE

BN.2

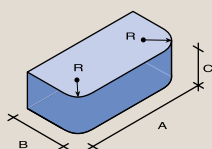
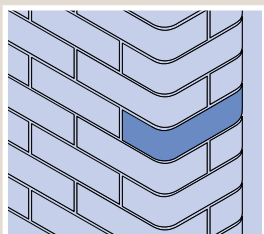

TYPE	A	B	C	R
BN.2.1	215	102	65	25
BN.2.2	215	102	65	51

Bullnose Bricks

GROUP BN

SINGLE BULLNOSE STOP (left and right hand)

BN.3

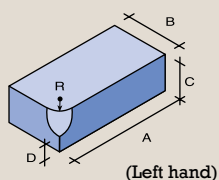
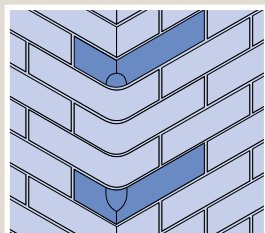

TYPE	A	B	C	D	R
BN.3.1	215	102	65	25	25
BN.3.2	215	102	65	25	51

Associated special brick: BN.1

DOUBLE BULLNOSE STOP

BN.4

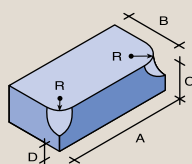
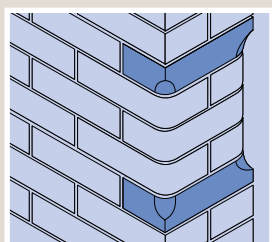

TYPE	A	B	C	D	R
BN.4.1	215	102	65	25	25
BN.4.2	215	102	65	25	51

Associated special bricks: BN.1, BN.2

SINGLE BULLNOSE HEADER ON FLAT

BN.5

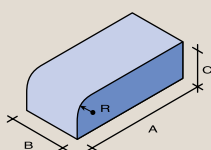
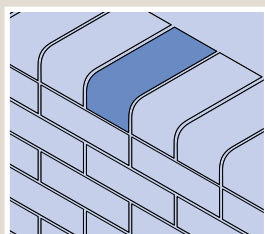

TYPE	A	B	C	R
BN.5.1	215	102	65	25
BN.5.2	215	102	65	51

Bullnose Bricks

GROUP BN

SINGLE BULLNOSE STRETCHER ON FLAT

BN.6

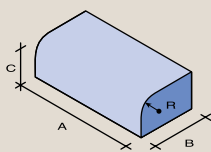
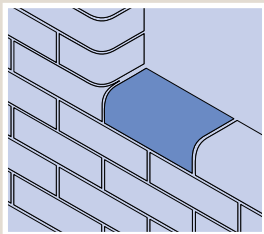

TYPE	A	B	C	R
BN.6.1	215	102	65	25
BN.6.2	215	102	65	51

SINGLE BULLNOSE INTERNAL RETURN, STRETCHER FAIR-FACED (left and right hand)

BN.7

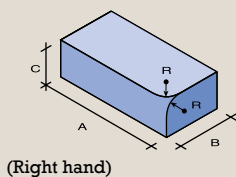
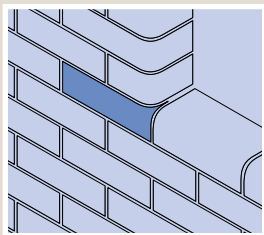

TYPE	A	B	C	R
BN.7.1	215	102	65	25
BN.7.2	215	102	65	51
BN.7.3	215	102	215	25
BN.7.4	215	102	215	51

Associated special bricks: BN.1, BN.5, BN.6

Bullnose Bricks

GROUP BN

SINGLE BULLNOSE INTERNAL RETURN, HEADER FAIR-FACED (left and right hand)

BN.8

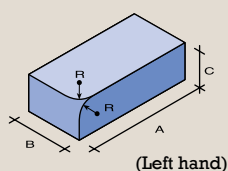
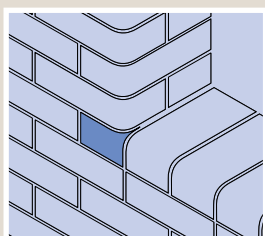

TYPE	A	B	C	R
BN.8.1	215	102	65	25
BN.8.2	215	102	65	51
BN.8.3	215	102	215	25
BN.8.4	215	102	215	51

Associated special bricks: BN.1, BN.5, BN.6

BULLNOSE INTERNAL RETURN, FLAT FAIR-FACED (left and right hand)

BN.9

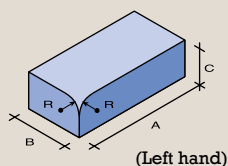
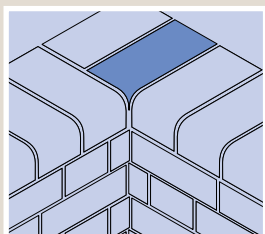

TYPE	A	B	C	R
BN.9.1	215	102	65	25
BN.9.2	215	102	65	51

Associated special bricks: BN.5, BN.6

Bullnose Bricks

GROUP BN

BULLNOSE EXTERNAL RETURN ON EDGE (left and right hand)

BN.10

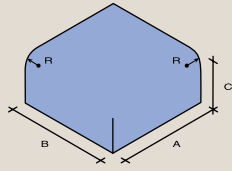
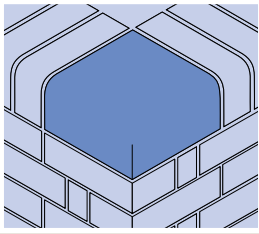

Associated special brick: BN.1

TYPE	A	B	C	R
BN.10.1	215	65	102	25
BN.10.2	215	65	102	51
BN.10.3	215	215	102	25
BN.10.4	215	215	102	51

BULLNOSE EXTERNAL RETURN ON FLAT (left and right hand)

BN.11

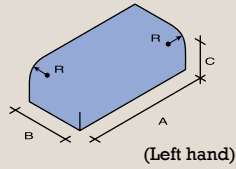
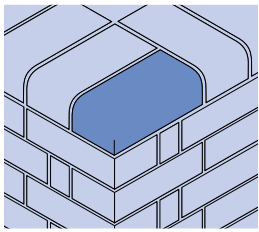

Associated special bricks: BN.5, BN.6

TYPE	A	B	C	R
BN.11.1	215	102	65	25
BN.11.2	215	102	65	51
BN.11.3	215	215	65	25
BN.11.4	215	215	65	51

BULLNOSE MITRE (left and right hand)

BN.12

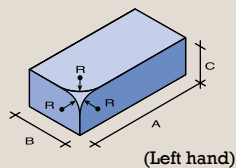
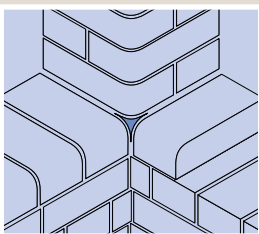

Associated special bricks: BN.1, BN.5, BN.6

TYPE	A	B	C	R
BN.12.1	215	103	65	25
BN.12.2	215	103	65	51



Bullnose Bricks

GROUP BN

BULLNOSE DOUBLE HEADER ON FLAT

BN.13

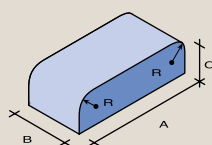
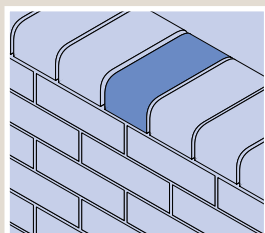

TYPE	A	B	C	R
BN.13.1	215	102	65	25
BN.13.2	215	102	65	51

BULLNOSE DOUBLE STRETCHER ON FLAT

BN.14

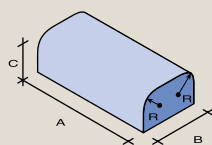
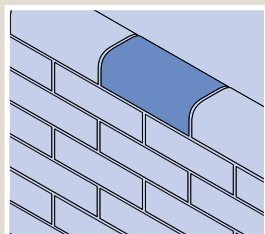

TYPE	A	B	C	R
BN.14.1	215	102	65	25
BN.14.2	215	102	65	51

Bullnose Bricks

GROUP BN

**STOP END TO DOUBLE BULLNOSE ON EDGE
AND TO BULLNOSE DOUBLE HEADER ON FLAT**
(square corners on bed)

BN.15

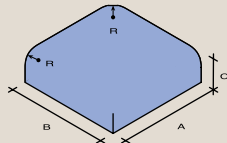
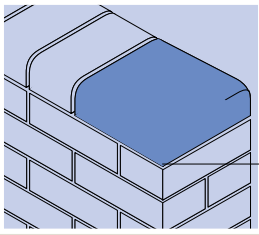

Square corners on bed

TYPE	A	B	C	R
BN.15.1	215	159	102	25
BN.15.2	215	159	102	51
BN.15.3	215	215	102	25
BN.15.4	215	215	102	51
BN.15.5	215	159	65	25
BN.15.6	215	159	65	51
BN.15.7	215	215	65	25
BN.15.8	215	215	65	51

Associated special bricks:
BN.2, BN.13

COWNOSE

BN.16

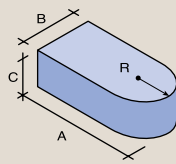
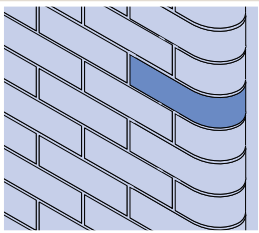

TYPE	A	B	C	R
BN.16.1	215	103	65	25
BN.16.2	215	103	65	51

COWNOSE STOP

BN.17

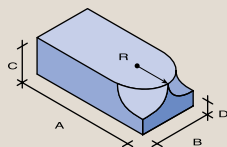
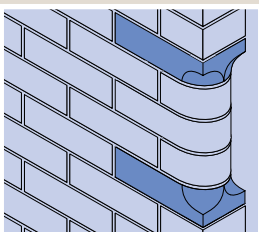

Associated special brick: BN.16

TYPE	A	B	C	D	R
BN.17.1	215	102	65	25	25
BN.17.2	215	102	65	25	51



Bullnose Bricks

GROUP BN

STOP END TO DOUBLE BULLNOSE ON EDGE AND TO BULLNOSE DOUBLE HEADER ON FLAT
(rounded corners on bed)

BN.18

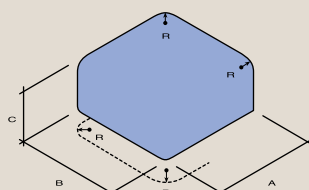
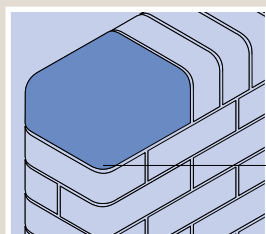

Rounded corners on bed

TYPE	A	B	C	R
BN.18.1	215	159	102	25
BN.18.2	215	159	102	51
BN.18.3	215	215	102	25
BN.18.4	215	215	102	51
BN.18.5	215	159	65	25
BN.18.6	215	159	65	51
BN.18.7	215	215	65	25
BN.18.8	215	215	65	51

Associated special bricks:
BN.1, BN.2, BN.13

EXTERNAL RETURN TO DOUBLE BULLNOSE ON EDGE AND TO BULLNOSE DOUBLE HEADER ON FLAT
(square corners on bed)

BN.19

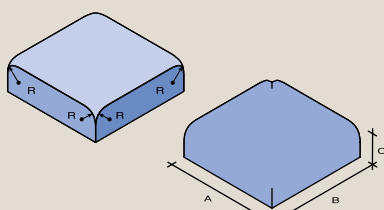
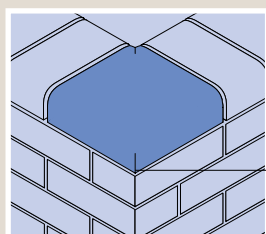

Square corners on bed

TYPE	A	B	C	R
BN.19.1	215	215	102	25
BN.19.2	215	215	102	51
BN.19.3	215	215	65	25
BN.19.4	215	215	65	51

Associated special bricks:
BN.2, BN.13

Bullnose Bricks

GROUP BN

EXTERNAL RETURN TO DOUBLE BULLNOSE ON EDGE AND TO BULLNOSE DOUBLE HEADER ON FLAT (rounded corners on bed)

BN.20

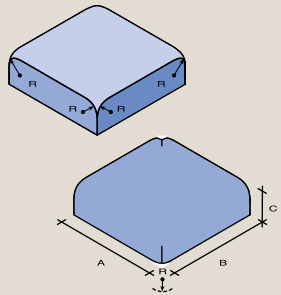
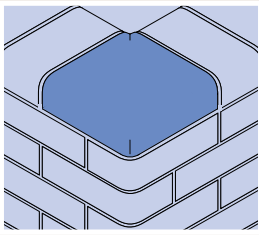

TYPE	A	B	C	R
BN.20.1	215	215	102	25
BN.20.2	215	215	102	51
BN.20.3	215	215	65	25
BN.20.4	215	215	65	51

Associated special bricks: BN.1, BN.2, BN.13

DOUBLE BULLNOSE EXTERNAL RETURN TO DOUBLE BULLNOSE ON EDGE AND TO BULLNOSE DOUBLE HEADER ON FLAT

BN.21

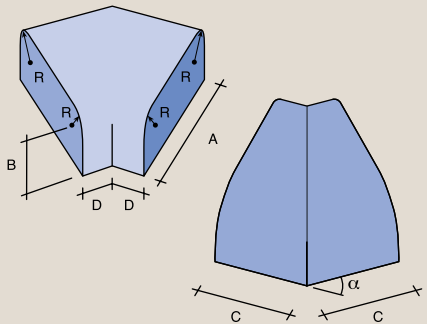
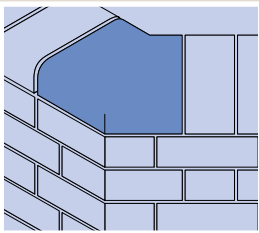

TYPE	A	B	C	D	R	α
BN.21.1	215	102	159	101	25	30°
BN.21.2	215	102	159	101	51	30°
BN.21.3	215	65	159	101	25	30°
BN.21.4	215	65	159	101	51	30°
BN.21.5	215	102	159	70	25	45°
BN.21.6	215	102	159	70	51	45°
BN.21.7	215	65	159	70	25	45°
BN.21.8	215	65	159	70	51	45°
BN.21.9	215	102	159	35	25	60°
BN.21.10	215	102	159	35	51	60°
BN.21.11	215	65	159	35	25	60°
BN.21.12	215	65	159	35	51	60°

Associated special bricks: BN.2, BN.13, AN.1, AN.2, AN.3



Angle and Cant Bricks

GROUP AN

Angle bricks generally serve a functional purpose where it is necessary to carry a building element through an angle other than 90° . For application see Appendix C.

SQUINT (left or right hand)

AN.1

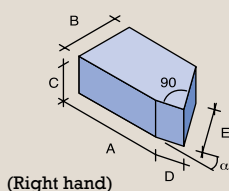
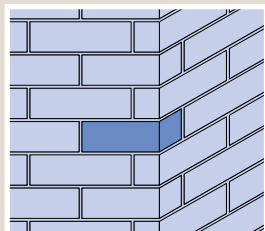

TYPE	A	B	C	D	E	α
AN.1.1	164	102	65	51	89	30°
AN.1.2	164	102	65	51	94	45°
AN.1.3	164	102	65	51	117	60°

EXTERNAL ANGLE (left or right hand)

AN.2

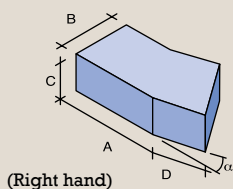
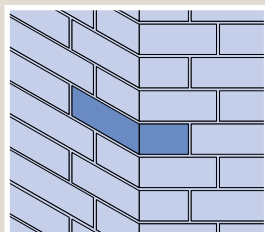

TYPE	A	B	C	D	α
AN.2.1	159	102	65	103	30^{o*}
AN.2.2	159	102	65	103	45^{o*}
AN.2.3	159	102	65	103	60^{o*}
AN.2.4	215	102	65	103	$30^{o\dagger}$
AN.2.5	215	102	65	103	$45^{o\dagger}$
AN.2.6	215	102	65	103	$60^{o\dagger}$

NOTE: Some types of brick may not be available with $A=215$

* Suitable for quarter bond without cutting

† Suitable for half bond without cutting

Angle and Cant Bricks

GROUP AN

Cant bricks are typically used for feature brickwork where crisp, clean lines are required e.g. corner details, window/door reveals, pier work. They can also be used for capping (see Group CP).

INTERNAL ANGLE (DOG LEG) (left or right hand)

AN.3

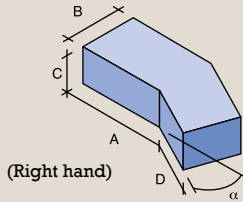
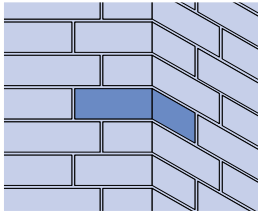

TYPE	A	B	C	D	α
AN.3.1	164	102	65	51	30 ^{o†}
AN.3.2	164	102	65	51	45 ^{o†}
AN.3.3	164	102	65	51	60 ^{o†}
AN.3.4	159	102	65	102	30 ^{o*}
AN.3.5	159	102	65	102	45 ^{o*}
AN.3.6	159	102	65	102	60 ^{o*}
AN.3.7	215	102	65	102	30 ^{o†}
AN.3.8	215	102	65	102	45 ^{o†}
AN.3.9	215	102	65	102	60 ^{o†}

NOTE: Some types of brick may not be available with A=215
 * Suitable for quarter bond without cutting
 † Suitable for half bond without cutting

BIRDSMOUTH

AN.4

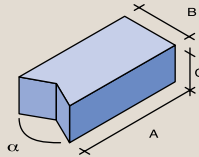
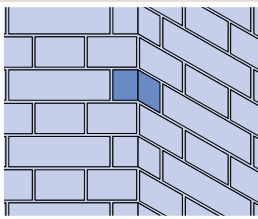

TYPE	A	B	C	α
AN.4.1	215	102	65	120 ^o
AN.4.2	215	102	65	135 ^o
AN.4.3	215	102	65	150 ^o

SINGLE CANT (left or right hand)

AN.5

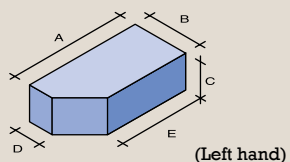
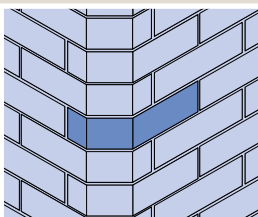

TYPE	A	B	C	D	E
AN.5.1	215	102	65	46	159
AN.5.2	215	102	65	60	173



Angle and Cant Bricks

GROUP AN

DOUBLE CANT

AN.6

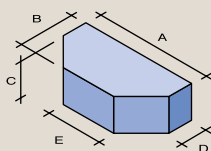
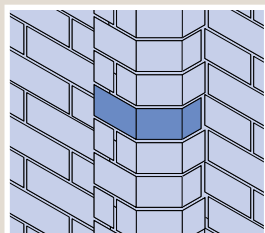

TYPE	A	B	C	D	E
AN.6.1	215	102	65	46	102
AN.6.2	215	102	65	60	131

SINGLE CANT RETURN

AN.7

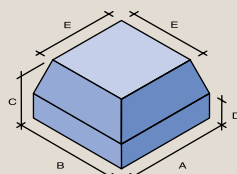
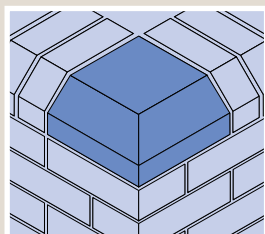

TYPE	A	B	C	D	E
AN.7.1	215	215	102	46	159
AN.7.2	215	215	102	60	173

Associated special brick: AN.5

SINGLE CANT RETURN WITH INTERNAL MITRE (square external corner on bed)

AN.8

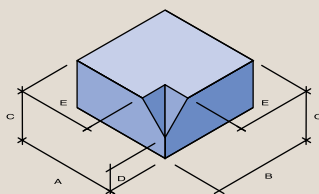
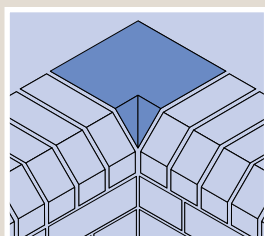

TYPE	A	B	C	D	E
AN.8.1	215	215	102	46	159
AN.8.2	215	215	102	60	173

Associated special brick: AN.5

NOTE: Faced on 2 full stretchers

Angle and Cant Bricks

GROUP AN

SINGLE CANT INTERNAL RETURN WITH INTERNAL SLOPE

(square external corner on bed)

AN.9

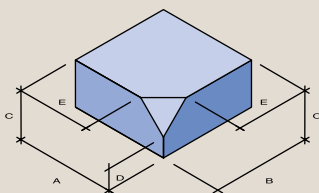
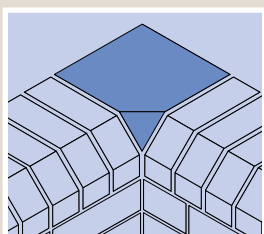

TYPE	A	B	C	D	E
AN.9.1	215	215	102	46	159
AN.9.2	215	215	102	60	173

Associated special brick: AN.5

NOTE: Faced on 2 full stretchers

SINGLE CANT EXTERNAL ANGLE

AN.10

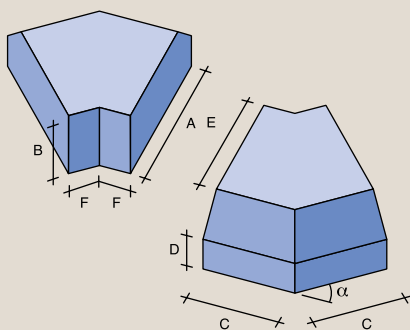
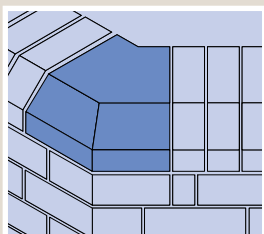

TYPE	A	B	C	D	E	F	α
AN.10.1	215	102	159	46	159	101	30°
AN.10.2	215	102	159	60	173	101	30°
AN.10.3	215	102	159	46	159	70	45°
AN.10.4	215	102	159	60	173	70	45°
AN.10.5	215	102	159	46	159	35	60°
AN.10.6	215	102	159	60	173	35	60°

Associated special bricks: AN.2, AN.5



Angle and Cant Bricks

GROUP AN

SINGLE CANT INTERNAL ANGLE

AN.11

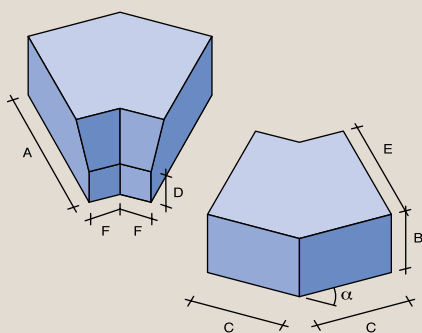
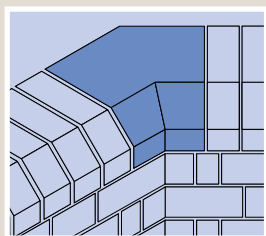

TYPE	A	B	C	D	E	F	α
AN.11.1	215	102	159	46	159	101	30°
AN.11.2	215	102	159	60	173	101	30°
AN.11.3	215	102	159	46	159	70	45°
AN.11.4	215	102	159	60	173	70	45°
AN.11.5	215	102	159	46	159	35	60°
AN.11.6	215	102	159	60	173	35	60°

Associated special bricks: AN.3, AN.5

DOUBLE CANT STOP END

(square corners on bed)

AN.12

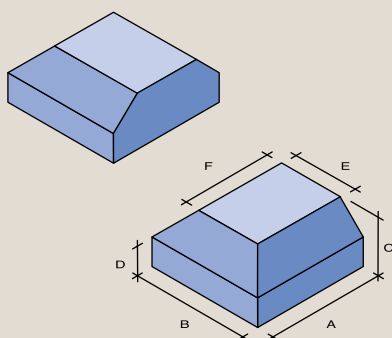
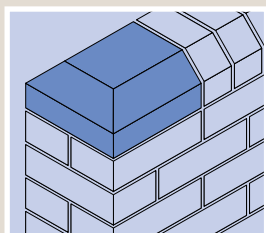

TYPE	A	B	C	D	E	F
AN.12.1	215	215	102	46	102	159
AN.12.2	215	215	102	60	131	173

Associated special brick: AN.6

Angle and Cant Bricks

GROUP AN

DOUBLE CANT STOP END

(canted corners on bed)

AN.13

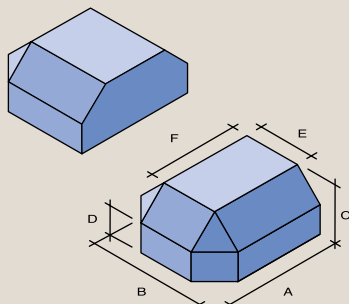
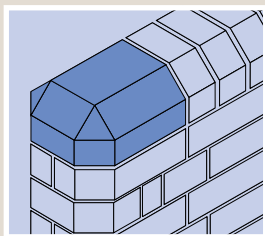

TYPE	A	B	C	D	E	F
AN.13.1	215	215	102	46	103	159
AN.13.2	215	215	102	60	131	173

Associated special bricks: AN.5, AN.6

DOUBLE CANT EXTERNAL RETURN WITH INTERNAL MITRE

(square corners on bed)

AN.14

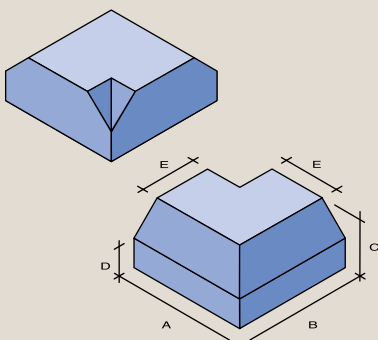
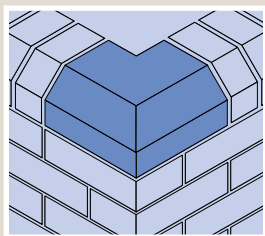

TYPE	A	B	C	D	E
AN.14.1	215	215	102	46	102
AN.14.2	215	215	102	60	131

Associated special brick: AN.6



Angle and Cant Bricks

GROUP AN

DOUBLE CANT EXTERNAL RETURN WITH INTERNAL MITRE

(canted corners on bed)

AN.15

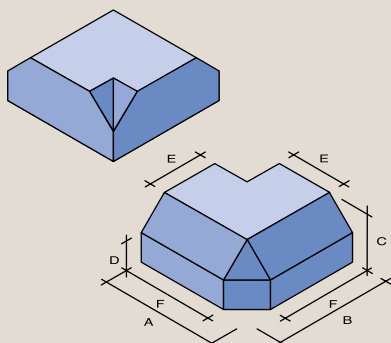
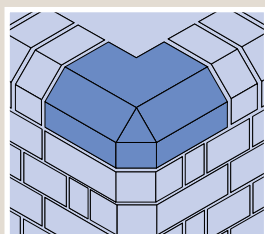

TYPE	A	B	C	D	E	F
AN.15.1	215	215	102	46	102	159
AN.15.2	215	215	102	60	131	173

Associated special bricks: AN.5, AN.6

DOUBLE CANT EXTERNAL RETURN WITH INTERNAL SLOPE

(square corners on bed)

AN.16

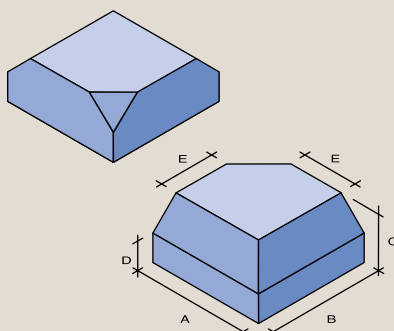
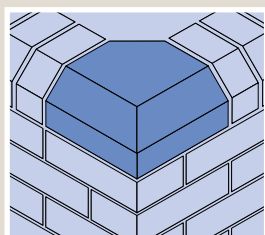

TYPE	A	B	C	D	E
AN.16.1	215	215	102	46	102
AN.16.2	215	215	102	60	131

Associated special brick: AN.6

Angle and Cant Bricks

GROUP AN

DOUBLE CANT EXTERNAL RETURN WITH INTERNAL SLOPE (canted corners on bed)

AN.17

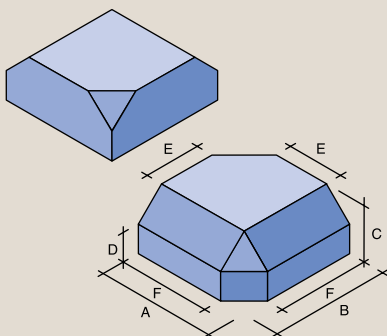
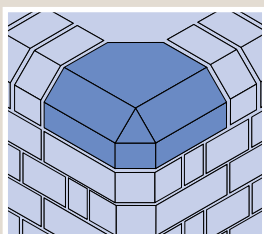

TYPE	A	B	C	D	E	F
AN.17.1	215	215	102	46	103	159
AN.17.2	215	215	102	60	131	173

Associated special bricks: AN.5, AN.6

DOUBLE CANT ANGLE

AN.18

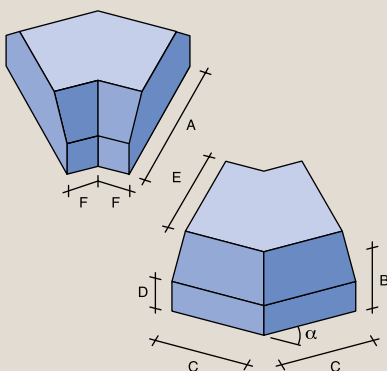
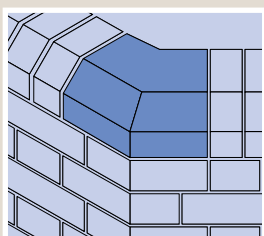

TYPE	A	B	C	D	E	F	θ
AN.18.1	215	102	159	46	102	101	30°
AN.18.2	215	102	159	60	131	101	30°
AN.18.3	215	102	159	46	102	70	45°
AN.18.4	215	102	159	60	131	70	45°
AN.18.5	215	102	159	46	102	35	60°
AN.18.6	215	102	159	60	131	35	60°

Associated special bricks: AN.2, AN.3, AN.6



Plinth Bricks

GROUP PL

Typically used for aesthetic detailing where hard lines are required e.g. returns, window cills, corbelling details, kerbs and capping (see Group CP).

PLINTH STOP OR CANT STOP (left or right hand)

PL.1

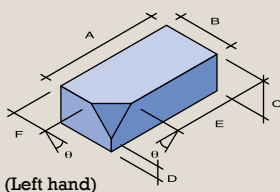
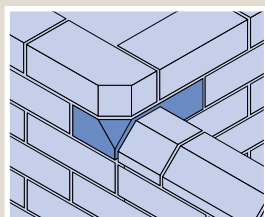

(Left hand)

TYPE	A	B	C	D	E	F	θ
PL.1.1	215	102	65	9	159	46	45°
PL.1.2	215	102	65	23	173	60	45°

Associated special bricks: PL.2, PL.3, AN.5

PLINTH HEADER

PL.2

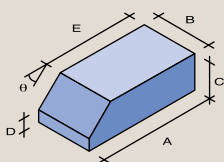
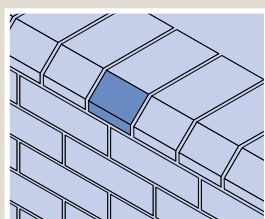

TYPE	A	B	C	D	E	θ
PL.2.1	215	102	65	9	159	45°
PL.2.2	215	102	65	23	173	45°

PLINTH STRETCHER

PL.3

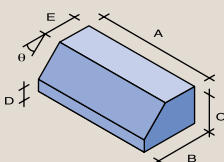
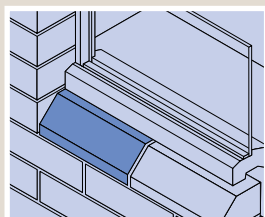

TYPE	A	B	C	D	E	θ
PL.3.1	215	102	65	9	46	45°
PL.3.2	215	102	65	23	60	45°

Plinth Bricks

GROUP PL

PLINTH INTERNAL RETURN (left or right hand)

PL.4

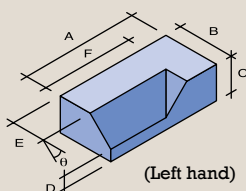
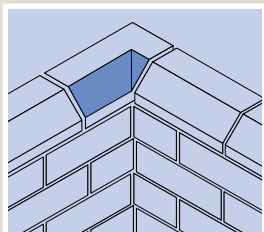

TYPE	A	B	C	D	E	F	θ
PL.4.1	215	102	65	9	46	169	45°
PL.4.2	215	102	65	23	60	155	45°

Associated special brick: PL.3

PLINTH INTERNAL RETURN (short) (left or right hand)

PL.5

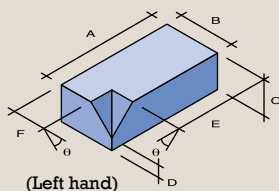
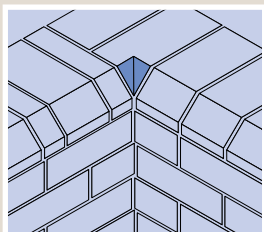

TYPE	A	B	C	D	E	F	θ
PL.5.1	215	102	65	9	159	46	45°
PL.5.2	215	102	65	23	173	60	45°

Associated special bricks: PL.2, PL.3

Plinth Bricks

GROUP PL

PLINTH INTERNAL ANGLE (left or right hand)

PL.6

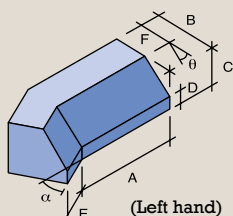
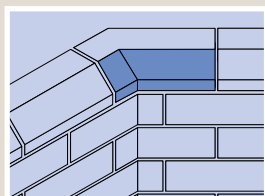

TYPE	A	B	C	D	E	F	α	θ
PL.6.1	164	102	65	9	51	46	30°†	45°
PL.6.2	164	102	65	23	51	60	30°†	45°
PL.6.3	164	102	65	9	51	46	45°†	45°
PL.6.4	164	102	65	23	51	60	45°†	45°
PL.6.5	164	102	65	9	51	46	60°†	45°
PL.6.6	164	102	65	23	51	60	60°†	45°
PL.6.7	159	102	65	9	102	46	30°*	45°
PL.6.8	159	102	65	23	102	60	30°*	45°
PL.6.9	159	102	65	9	102	46	45°*	45°
PL.6.10	159	102	65	23	102	60	45°*	45°
PL.6.11	159	102	65	9	102	46	60°*	45°
PL.6.12	159	102	65	23	102	60	60°*	45°
PL.6.13	215	102	65	9	102	46	30°†	45°
PL.6.14	215	102	65	23	102	60	30°†	45°
PL.6.15	215	102	65	9	102	46	45°†	45°
PL.6.16	215	102	65	23	102	60	45°†	45°
PL.6.17	215	102	65	9	102	46	60°†	45°
PL.6.18	215	102	65	23	102	60	60°†	45°

Associated special bricks: PL.3, AN.2

NOTE: Some types of brick may not be available with A=215

* Suitable for quarter bond without cutting † Suitable for half bond without cutting

PLINTH EXTERNAL RETURN (left or right hand)

PL.7

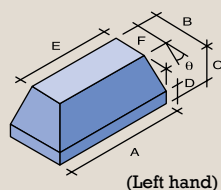
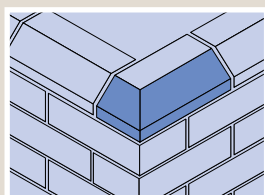

TYPE	A	B	C	D	E	F	θ
PL.7.1	215	102	65	9	159	46	45°
PL.7.2	215	102	65	23	173	60	45°

Associated special brick: PL.3

Plinth Bricks

GROUP PL

PLINTH EXTERNAL ANGLE (left or right hand)

PL.8

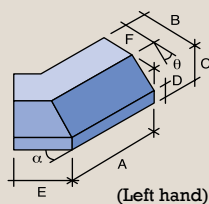
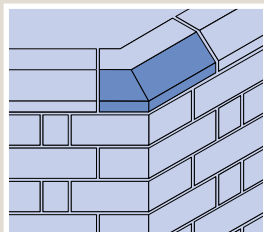

TYPE	A	B	C	D	E	F	α	θ
PL.8.1	159	102	65	9	102	46	$30^{\circ\text{†}}$	45°
PL.8.2	159	102	65	23	102	60	$30^{\circ\text{†}}$	45°
PL.8.3	159	102	65	9	102	46	$45^{\circ\text{†}}$	45°
PL.8.4	159	102	65	23	102	60	$45^{\circ\text{†}}$	45°
PL.8.5	159	102	65	9	102	46	$60^{\circ\text{†}}$	45°
PL.8.6	159	102	65	23	102	60	$60^{\circ\text{†}}$	45°
PL.8.7	215	102	65	9	102	46	$30^{\circ\text{‡}}$	45°
PL.8.8	215	102	65	23	102	60	$30^{\circ\text{‡}}$	45°
PL.8.9	215	102	65	9	102	46	$45^{\circ\text{‡}}$	45°
PL.8.10	215	102	65	23	102	60	$45^{\circ\text{‡}}$	45°
PL.8.11	215	102	65	9	102	46	$60^{\circ\text{‡}}$	45°
PL.8.12	215	102	65	23	102	60	$60^{\circ\text{‡}}$	45°

Associated special bricks: PL.3, AN.2

PLINTH SQUINT (left or right hand)

PL.9

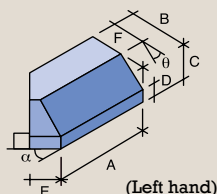
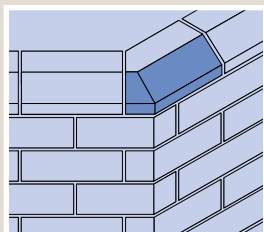

TYPE	A	B	C	D	E	F	α	θ
PL.9.1	164	102	65	9	51	46	$30^{\circ\text{†}}$	45°
PL.9.2	164	102	65	23	51	60	$30^{\circ\text{†}}$	45°
PL.9.3	164	102	65	9	51	46	$45^{\circ\text{†}}$	45°
PL.9.4	164	102	65	23	51	60	$45^{\circ\text{†}}$	45°
PL.9.5	164	102	65	9	51	46	$60^{\circ\text{†}}$	45°
PL.9.6	164	102	65	23	51	60	$60^{\circ\text{†}}$	45°

Associated special bricks: PL.3, AN.1



Arch Bricks

GROUP AR

Typically used to provide structural stability in curved elements such as arches or for aesthetic detailing e.g. circular windows.

TAPERED HEADER

AR.1

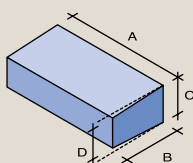
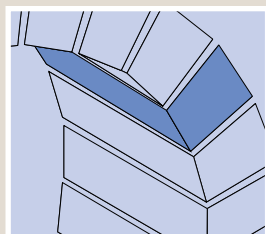

TYPE	UNIT DIMENSIONS				IDEAL SPAN*		
	A	B	C	D	DIMENSIONS	NO. OF WHOLE BRICKS	NO. OF BRICKS' IN SEMI-CIRCLE
AR.1.1	215	102	75	59	910mm	4	20 or 21
AR.1.2	215	102	75	64	1360mm	6	28 or 29
AR.1.3	215	102	75	66	1810mm	8	36 or 37
AR.1.4	215	102	75	69	2710mm	12	53 or 54

* It is possible to use standard arch bricks for spans other than the ideal, ranging from 800mm to 3000mm in half-brick increments, by varying the number of bricks, providing the slight tapering of the joints is aesthetically acceptable. The taper may vary between 0.9mm and 1.6mm for the smallest span to less than 1mm for the larger spans.

† Parallel joints of acceptable width are achieved using either of the alternative number of bricks in the semi-circle if the bricks confirm to the work sizes.

The actual size of bricks normally varies slightly from the work size. If the bricks on site are larger, then the smaller number of bricks in the semi-circle would be more appropriate and vice versa.

Note: Faced on 2 headers

TAPERED STRETCHER

AR.2

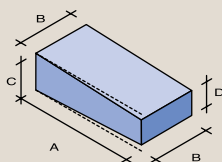
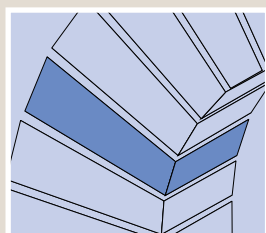

TYPE	UNIT DIMENSIONS				IDEAL SPAN*		
	A	B	C	D	DIMENSIONS	NO. OF WHOLE BRICKS	NO. OF BRICKS' IN SEMI-CIRCLE
AR.2.1	215	102	75	48	910mm	4	24 or 25
AR.2.2	215	102	75	55	1360mm	6	33 or 34
AR.2.3	215	102	75	58	1810mm	8	41 or 42
AR.2.4	215	102	75	63	2710mm	12	58 or 59

* This format is not as versatile in application as the AR series because the longer voussoir joint accentuates splays. Tolerance allowances limit versatility further.

† Parallel joints of acceptable width are achieved using either of the alternative number of bricks in the semi-circle if the bricks confirm to the work sizes.

Radial Bricks

GROUP RD

As a functional brick, typically used for structures such as industrial chimneys. Also particularly effective used as an aesthetic device producing a sweeping "curved" effect.

RADIAL HEADER

RD.1

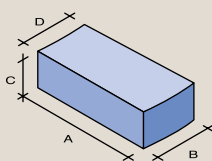
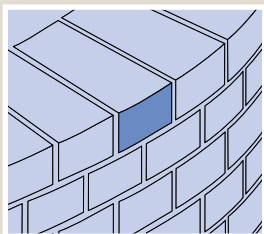

TYPE	UNIT DIMENSIONS				IDEAL RADIUS		NO. OF BRICKS IN QUADRANT
	A	B	C	D	OUTER	INNER	
RD.1.1	215	108	65	52	450mm	235	6
RD.1.2	215	108	65	70	675mm	460	9
RD.1.3	215	108	65	80	900mm	685	12
RD.1.4	215	108	65	89	1350mm	1135	18
RD.1.5	215	108	65	97	2250mm	2035	30
RD.1.6	215	108	65	103	5400mm	5185	72

* Dimensions B and D in types RD.1 are segmental lengths

Note: Faced on 2 headers

RADIAL STRETCHER

RD.2

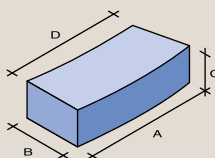
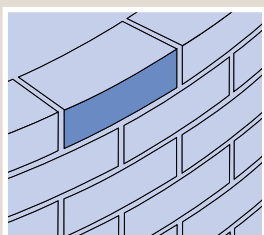

TYPE	UNIT DIMENSIONS				IDEAL RADIUS		NO. OF BRICKS IN QUADRANT
	A	B	C	D	OUTER	INNER	
RD.2.1	226	102	65	172	450mm	347	3
RD.2.2	226	102	65	190	675mm	572	4.5
RD.2.3	226	102	65	199	900mm	797	6
RD.2.4	226	102	65	208	1350mm	1247	9
RD.2.5	226	102	65	215	2250mm	2147	15
RD.2.6	226	102	65	221	5400mm	5297	36

* Dimensions B and D in types RD.2 are segmental lengths

Note: Faced on 2 headers



Brick Slips

GROUP SL

Typically used to mask reinforced concrete frames and for interior work.

BRICK FACE SLIP

SL.1

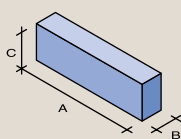
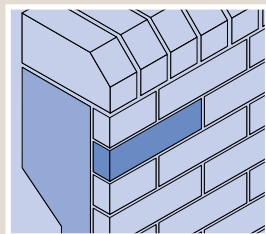

TYPE	A	B	C
SL.1.1	215	25	65
SL.1.2	215	30	65
SL.1.3	215	40	65
SL.1.4	215	50	65

BRICK BED SLIP

SL.2

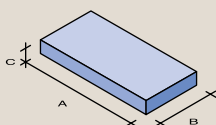
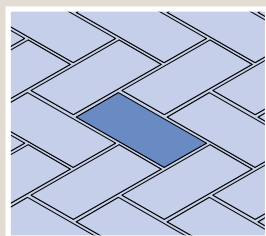

TYPE	A	B	C
SL.2	215	102	25

Soldier Bricks

GROUP SD

Typically used as an aesthetic means of returning a soldier course detail.

SOLDIER RETURN

SD.1

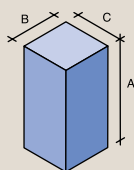
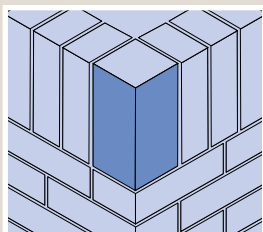

TYPE	A	B	C
SD.1.1	215	65	65
SD.1.2	215	102	102

INTERNAL SOLDIER RETURN TO SINGLE CANT ON END

SD.2

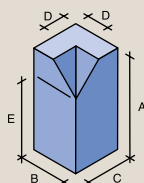
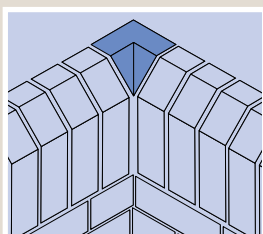

TYPE	A	B	C	D	E
SD.2.1	215	102	102	46	159
SD.2.2	215	102	102	60	173

EXTERNAL SOLDIER RETURN TO SINGLE CANT ON END

SD.3

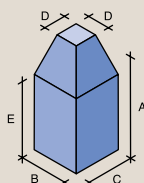
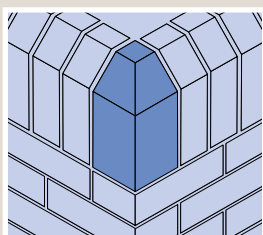

TYPE	A	B	C	D	E
SD.3.1	215	102	102	46	159
SD.3.2	215	102	102	60	173



Victorian Old Type Specials

GROUP VN

Typically used as decorative feature bricks.

HALF DIAMOND STRETCHER

VN.1

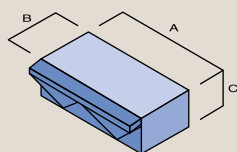

TYPE	A	B	C
VN.1.1	215	102	65

NOTE: Other depths also available

PYRAMID STRETCHER

VN.2

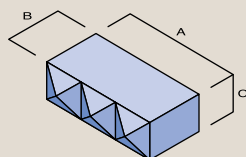

TYPE	A	B	C
VN.2.1	215	102	65

NOTE: Other depths also available

OGEE STRETCHER

VN.3

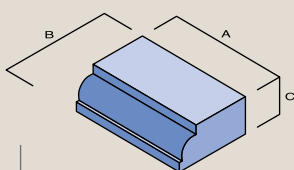

TYPE	A	B	C
VN.3.1	215	145	65

NOTE: Other depths also available

OGEE STRETCHER

VN.4

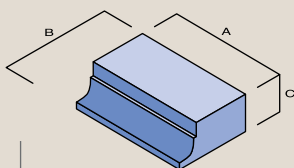

TYPE	A	B	C
VN.4.1	215	137	65

NOTE: Other depths also available

Victorian Old Type Specials

GROUP VN

FEATURE QUOIN STRETCHER (left or right hand)

VN.5

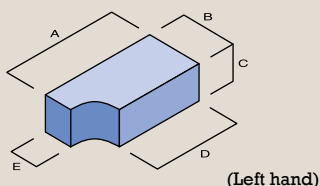

(Left hand)

TYPE	A	B	C	D	E
VN.5.1	215	102	65	165	52

NOTE: Other depths also available

SINGLE BULLNOSE WINDOW REVEAL (left or right hand)

(left or right hand)

VN.6

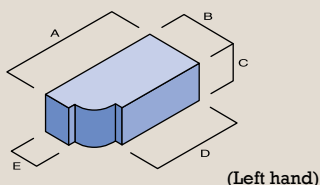

(Left hand)

TYPE	A	B	C	D	E
VN.6.1	215	102	65	160	47

NOTE: Other depths also available

CORBEL PEDESTAL

VN.7

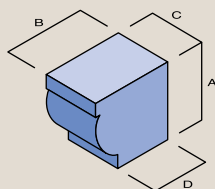

TYPE	A	B	C	D
VN.7.1	140	150	102	102



Victorian Old Type Specials

GROUP VN

WAVE COPING

VN.8

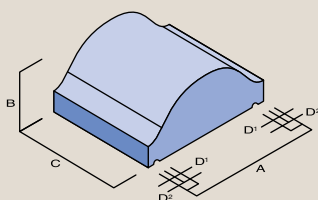

TYPE	A	B	C	D ¹	D ²
VN.8.1	310	140	285	13	15

WAVE COPING STOP END

VN.9

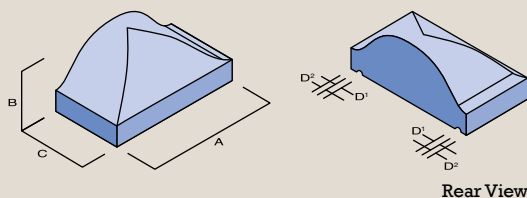

TYPE	A	B	C	D ¹	D ²
VN.9.1	310	140	184	13	15

PIER CAP

VN.10

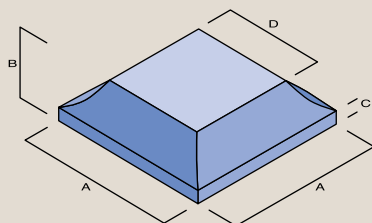

TYPE	A	B	C	D
VN.10.1	285	65	25	18.8

Victorian Old Type Specials

GROUP VN

STRETCHER SHORT

VN.11

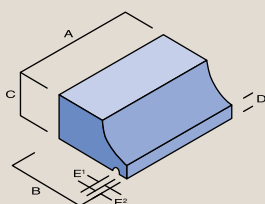

TYPE	A	B	C	D	E ¹	E ²
VN.11.1	215	140	65	25	13	5

STRETCHER COPING

VN.12

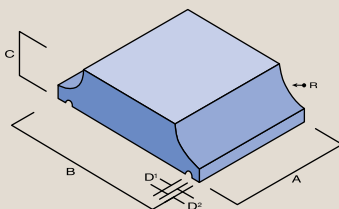

TYPE	A	B	C	D ¹	D ²	R
VN.12.1	215	285	65	13	15	51

OVERHANGING ANGLED CILL

VN.13

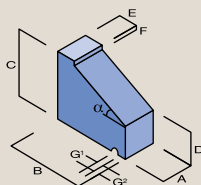

TYPE	A	B	C	D	E	F	G ¹	G ²	α
VN.13.1	65	152	140	65	35	7.5	12	15	30°
VN.13.2	102	152	140	65	35	7.5	12	15	30°
VN.13.3	215	152	140	65	35	7.5	12	15	30°
VN.13.4	65	152	215	65	35	10	12	15	50°
VN.13.5	102	152	215	65	35	10	12	15	50°
VN.13.6	215	152	215	65	35	10	12	15	50°

Victorian Old Type Specials

GROUP VN

STEPPED HEADER

VN.14

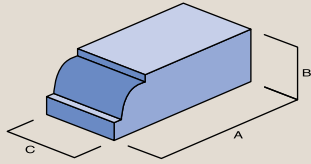

TYPE	A	B	C
VN.14.1	230	80	112.5

Appendices

Appendix A

Information to be considered when ordering bricks of special shapes.

When determining the specification of special shaped bricks consider which of the physical properties will be of significance in the finished brickwork and specify only these. Specification of properties which are not essential may restrict the choice of brick offered. Specifiers should pay particular attention to the clauses referred to in other British Standards in order to assess the significance of each property and the need to specify it.

The following information should be considered when ordering bricks of special shapes.

- (a) Product name or colour and texture (see 0.3)
- (b) Type number and description, right or left hand (if relevant, see 0.4), e.g. BN.3, single bullnose stop, right hand.
- (c) Faced surfaces (see 0.2)
- (d) Durability requirements. Bricks of special shapes that are to be used in positions where they are liable to be saturated and subject to freeze/thaw cycling, e.g. in parapets, copings, cappings and sills need to be suitably durable.

NOTE: Specifiers should consult with manufacturers or suppliers regarding the suitability of the bricks for use in such exposed positions.

In addition:

- (1) for freeze/thaw resistance of high density (HD) clay bricks, see 5.3.6 and B.3 of pr EN771-1 and annex C to this standard;
- (2) for freeze/thaw resistance of calcium silicate bricks, see 5.7 of BS EN771-2;
- (3) for freeze/thaw resistance of concrete bricks, see 5.7 of pr EN771-3;
- (4) for guidance on the use of bricks and mortars in position of varying degrees of exposure, see table 13 of BS 5628-3:2001.
- (e) Requirements for structural use, see BS EN771 series of standards and BS5628-1 and 2.
- (f) Where products are used to be other than in the orientation described in this standard, a drawing showing the proposed application should be included with the order to allow the implications for manufacture to be considered, e.g. the effect of perforation patterns if the brick is to be used in a situation where it is structurally loaded perpendicular to the line of the perforations.
- (g) Any special requirement for dimensional tolerances, see BS EN771 series of standards.
- (h) Any special requirement not covered by this standard, e.g. position of any perforations and holes (see 0.1), or acid-resistance.
- (i) Quantity.
- (j) Packaging requirements.
- (k) A schedule of deliveries to be agreed with the suppliers.

Appendix B

Guidance on the limits for size of individual bricks other than group NS.

Table 15

Guidance on the limits of size of individual bricks other than group NS

Work size dimension (mm)	Tolerance (mm)
Up to 25	±2
>25 to 120	±3
>120 to 220	±4
More than 220	±5

See also paragraph (a) in the Foreword.

Appendices

Appendix C

This is a guide to the application of squints and angle bricks to external and internal angles in brickwork.

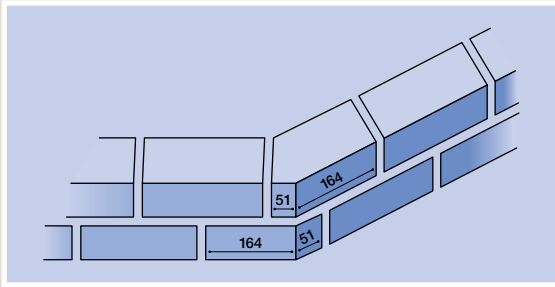

(a) Squint AN.1.1, AN.1.2, AN.1.3
Maintains half-bond without closer

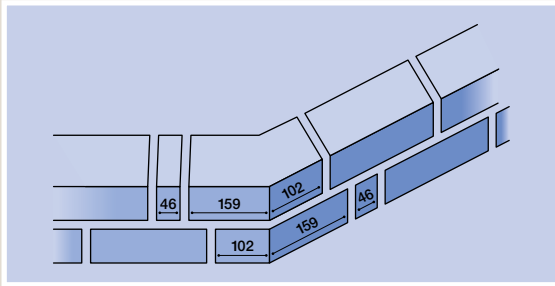

(b) External angles AN.2.1, AN.2.2, AN.2.3
Maintains half-bond with closer

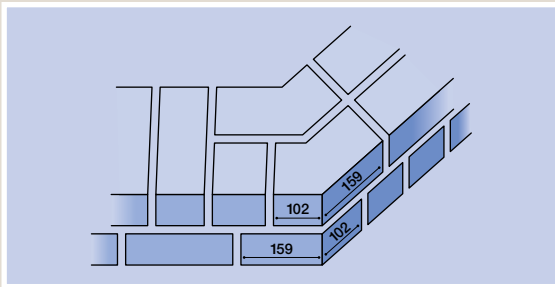

(c) External angles AN.2.1, AN.2.2, AN.2.3
Maintains quarter-bond without closer

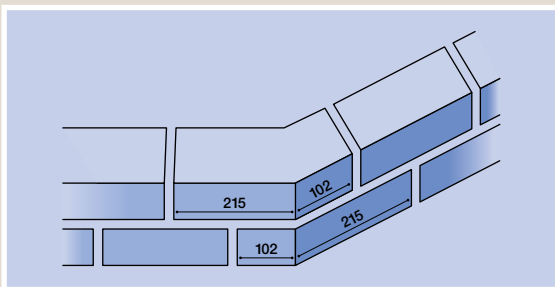

(d) External angles AN.2.4, AN.2.5, AN.2.6
Maintains half-bond without closer

Appendices

All dimensions in millimetres

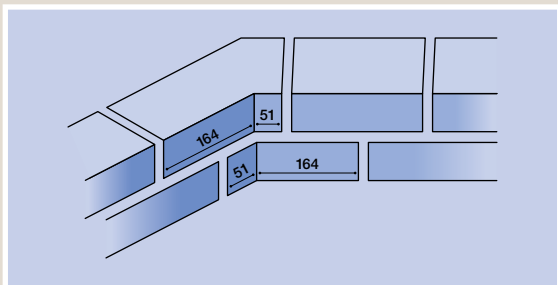

(e) Internal angle AN.3.1, AN.3.2, AN.3.3
Maintains half-bond without closer

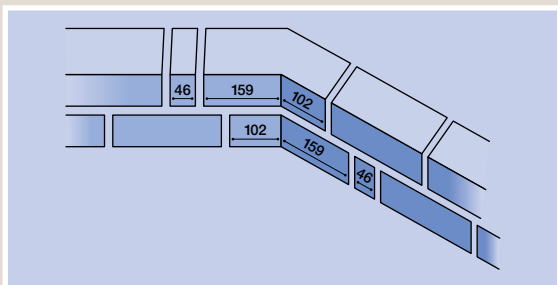

(f) Internal angle AN.3.4, AN.3.5, AN.3.6
Maintains half-bond with closer

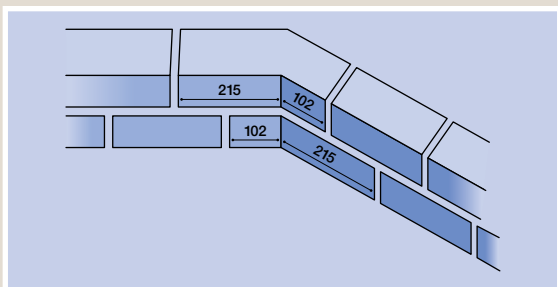

(g) Internal angle AN.3.7, AN.3.8, AN.3.9
Maintains half-bond without closer

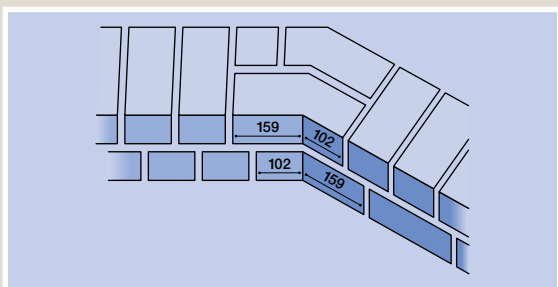

(h) Internal angle AN.3.4, AN.3.5, AN.3.6
Maintains quarter-bond

Specifications

0 INTRODUCTION

0.1 Forms of bricks

Although the diagrams in this standard indicate solid bricks, bricks of special shapes may be solid, frogged, cellular or perforated.

NOTE: The specifier should ascertain from the supplier the exact nature of any voids and consider the structural implications as well as the implications for constructional detailing.

0.2 Faced surfaces

The surfaces of the bricks which will be faced are indicated by shading in the diagrams shown in the tables in this standard. Surfaces not visible in the diagrams are not faced.

NOTE: If specifiers require other surfaces to be faced, they should consult the manufacturers or suppliers.

0.3 Colour and surface texture

With some types of bricks and manufacturing techniques, it is not possible to ensure that the colour and texture of all the exposed faces of special shapes exactly match those of the corresponding standard bricks.

NOTE: Specifiers should consult with the supplier at an early stage to establish their needs for a particular application.

0.4 Left and right-handed bricks

Left or right-handed versions will sometimes need to be specified, e.g.

- (a) where the special shape brick is asymmetric, e.g. a single bullnose stop (Type BN.3);
- (b) where the directional nature of the surface texture of the bricks requires them to be laid in one aspect to avoid variations in appearance in the built wall.

When a brick has a handed version the diagram indicates whether a left-hand (LH) or right-hand (RH) version is shown.

NOTE: The need to specify handed versions of single-frogged bricks in positions where compressive strength may be critical (see 0.5) may be avoided by, on the appropriate hand, filling the frog with mortar before laying it frog down. An example is the use of squint bricks (Group 4, Type AN.1) at both sides of an opening.

0.5 Compressive strength

Clay and Calcium Silicate bricks of special shapes and sizes may have a lower compressive strength than bricks made to EN771-1 and EN771-2 from the same raw materials.

NOTE: In positions where compressive strength may be critical, e.g. under the ends of lintels, it is usually necessary to fill any frogs in the bricks with mortar. Where strength is a critical design requirement the manufacturers should be consulted.

0.6 Durability

Bricks of special shapes which are to be used in positions where they are liable to be saturated and frozen, e.g. in parapets, copings, cappings and sills, need to be suitably durable (see item (e) of appendix A).

NOTE: Specifiers should consult with manufactures or suppliers regarding the suitability of the brick for use in such exposed positions.

1 SCOPE

This British Standard specifies the shapes and dimensions of bricks of special shapes and sizes made from clay, calcium silicate or concrete and intended for use in the construction of brick masonry. The dimensions and other requirements of standard bricks are covered by EN771-1, EN771-2, EN771-3.

NOTE: The purchaser should supply with his enquiry or order the information given in appendix A.

2 SHAPES AND DIMENSIONS

Unless otherwise stated all dimensions are in millimetres.



Northcot Brick Ltd

Blockley, Nr. Moreton-in-Marsh
Gloucestershire GL56 9LH

Tel: 01386 700551

Fax: 01386 700852

email: sales@northcotbrick.co.uk
website: www.northcotbrick.co.uk